

# ŠIROKOROZSAHOVÉ NÝTY

Série 1691 + 1661 + 1001

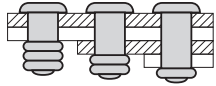
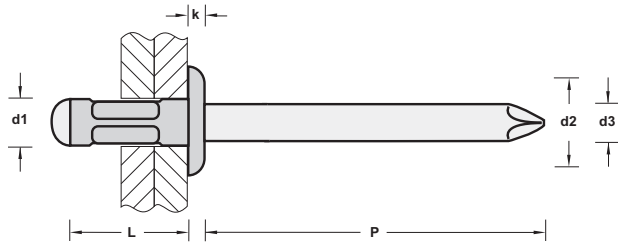

Všechny rozměry v mm.

d1 Ø	Ø  : 3.1 - 3.3
d2 Ø	: 6.0 [+/-0.24]
k	: ≤1.4
P	: ≥27
d3	: ~1.7
	: 655 N
	: 520 N

Všechny rozměry v mm.

d1 Ø	Ø  : 3.3 - 3.4
d2 Ø	: 6.0 - 6.7
k	: ≤1.1
P	: ≥31
d3	: ~1.75
	: 980 N
	: 680 N

	L [+1/-0.2]	Objednáací číslo
0.5- 3.0	6.0	10013006
0.8- 4.3	6.7	16915307
0.5- 5.0	8.0	10013008
2.5- 7.0	10.0	10013010
4.5- 9.0	12.0	10013012

0.5- 3.0	6.0	10013206
0.8- 4.8	7.9	16910410
0.5- 5.0	8.0	10013208
2.0- 6.5	9.5	10013209
1.2- 6.3	9.6	16610412
2.5- 7.0	10.0	10013210
3.5- 8.0	11.1	10013211
4.0- 7.9	11.2	16910414
4.5- 9.0	12.0	10013212
5.5- 9.5	13.5	16610416
6.5-11.0	14.0	10013214
8.5-13.0	16.0	10013216

Všechny rozměry v mm.

d1 Ø	Ø  : 4.1 - 4.3
d2 Ø	: 8.0 - 8.2
k	: ≤1.7
P	: ≥2.0
d3	: ~2.18
	: 1600 N
	: 1100 N

+0.08  
-0.15

Všechny rozměry v mm.

d1 Ø	Ø  : 4.9 - 5.2
d2 Ø	: 9.5 - 10.1
k	: ≤2.0
P	: ≥30
d3	: ~2.8
	: 2300 N
	: 1300 N

+0.08  
-0.15

Všechny rozměry v mm.

d1 Ø	Ø  : 6.6 - 6.9
d2 Ø	: 13.5
k	: ≤2.7
P	:
d3	: 4.0
	: 3100 N
	: 2500 N

+0.08  
-0.15

Série 1624 + 1461

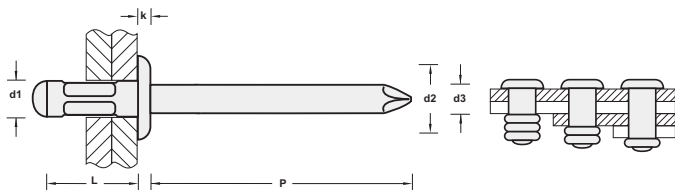

Všechny rozměry v mm.

d1 Ø	Ø  : 3.3 - 3.4
d2 Ø	: 7.2
k	: 0.9
P	: ≥27
d3	: ~2.1
	: 1710 N
	: 1335 N

11

	L [+1/-0.2]	Objednáací číslo
1.1- 4.0	9.5	16240411

Všechny rozměry v mm.

d1 Ø	Ø  : 4.1 - 4.2
d2 Ø	: 8.1
k	: 1.2
P	: ≥30
d3	: ~2.8
	: 2355 N
	: 1955 N

+0.05  
-0.15

Všechny rozměry v mm.

d1 Ø	Ø  : 4.9 - 5.0
d2 Ø	: 9.8
k	: 1.8
P	: ≥30
d3	: ~3.4
	: 3470 N
	: 3335 N (dle délky nýtu)

+0.05  
-0.15

	L [+1/-0.2]	Objednáací číslo
0.5- 2.5	6.0	10010406
0.5- 3.2	6.3	16910508
0.8- 4.7	7.9	16910510
0.5- 4.5	8.0	10014008
1.0- 6.0	9.5	10014009
1.2- 6.3	9.5	16910512
1.5- 6.5	10.0	10014010
3.5- 8.5	12.0	10014012
4.0- 9.6	12.7	16910516
5.5-10.5	14.0	10014014
7.5-12.5	16.0	10014016
6.4-12.7	16.7	16910521
8.5-13.5	17.0	10014017
9.5-14.5	18.0	10014018
11.5-16.5	20.0	10014020

0.5- 5.0	10.0	10014810
0.5- 5.5	10.3	10014811
1.6- 6.3	10.3	16910613
2.0- 7.0	12.0	10014812
4.0- 9.0	14.0	10014814
4.8-11.1	15.1	16910619
6.0-11.0	16.0	10014816
6.4-12.7	16.7	16910621
7.0-12.0	17.0	10014817
8.0-13.0	18.0	10014818
10.0-15.0	20.0	10014820
12.0-17.0	22.0	10014822
14.0-19.0	24.0	10014824
12.7-19.8	24.0	16910631
14.5-19.5	24.8	10014825
17.0-23.0	27.0	10014827
20.0-25.0	30.0	10014830

1.5- 8.3	16.8	16104506
----------	------	----------

ŠIROKOROZSAHOVÉ NÝTY

# Série 1171

**HLINÍK**  
AlMg 2,5

**OCEL**  
POZINKOVÁNO

## BÍLÝ LAK RAL 9010

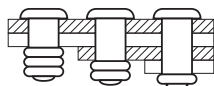
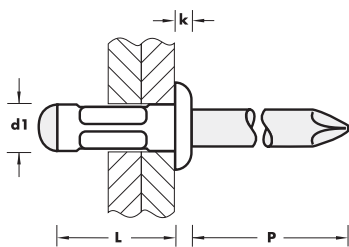

Všechny rozměry v mm.

<b>d1 Ø</b>	Ø $\text{---}$ : 3.1 [3.3 max]
<b>d2 Ø</b>	: 6.0 [+/-0.24]
<b>k</b>	: ≤1.4
<b>P</b>	: ≥27
<b>d3</b>	: 1.7
	⊕ : 654 N
	⊖ : 522 N

Všechny rozměry v mm.

<b>d1 Ø</b>	Ø $\text{---}$ : 3.3 [3.5 max]
<b>d2 Ø</b>	: 6.0 [+/-0.24]
<b>k</b>	: ≤1.4
<b>P</b>	: ≥27
<b>d3</b>	: 1.78
	⊕ : 980 N
	⊖ : 680 N

	L [+1/-0.2]	Objednáací číslo
1.0- 4.0	6.0	11713006
1.0- 5.5	8.0	11713008
2.5- 7.0	10.0	11713010
4.5- 9.0	12.0	11713012

0.5- 3.0	6.0	11713206
0.5- 5.0	8.0	11713208
2.0- 6.5	9.5	11713209
2.5- 7.0	10.0	11713210
3.5- 8.0	11.1	11713211
4.5- 9.0	12.0	11713212
5.5- 9.5	12.7	11713213
6.5-11.0	14.0	11713214
8.5-13.0	16.0	11713216

Všechny rozměry v mm.

<b>d1 Ø</b>	Ø $\text{---}$ : 4.1 [4.3 max]
<b>d2 Ø</b>	: 8.0 [+/-0.29]
<b>k</b>	: ≤1.7
<b>P</b>	: ≥27
<b>d3</b>	: 2.18
	⊕ : 1600 N
	⊖ : 1150 N

Všechny rozměry v mm.

<b>d1 Ø</b>	Ø $\text{---}$ : 4.9 [5.2 max]
<b>d2 Ø</b>	: 9.5 [+/-0.29]
<b>k</b>	: ≤2.0
<b>P</b>	: ≥27
<b>d3</b>	: 2.78
	⊕ : 2350 N
	⊖ : 1500 N

	L [+1/-0.2]	Objednáací číslo
0.5- 2.5	6.0	11714006
0.5- 4.5	8.0	11714008
1.0- 6.0	9.5	11714009
1.5- 6.5	10.0	11714010
3.5- 8.5	12.0	11714012
4.0- 9.5	12.7	11714013
5.5-10.5	14.0	11714014
7.5-12.5	16.0	11714016
8.5-13.5	17.0	11714017
9.5-14.5	18.0	11714018
11.5-16.5	20.0	11714020

0.5- 5.0	10.0	11714810
0.5- 5.5	10.3	11714811
2.0- 7.0	12.0	11714812
4.0- 9.0	14.0	11714814
5.0-10.5	15.1	11714815
6.0-11.0	16.0	11714816
7.0-12.0	17.0	11714817
8.0-13.0	18.0	11714818
10.0-15.0	20.0	11714820
12.0-17.0	22.0	11714822
14.0-19.0	24.0	11714824
14.5-19.5	24.8	11714825
17.0-23.0	27.0	11714827
20.0-25.0	30.0	11714830

# Série 1181

**HLINÍK**  
AlMg 2,5

**OCEL**  
POZINKOVÁNO

## ČERNÝ LAK RAL 9005

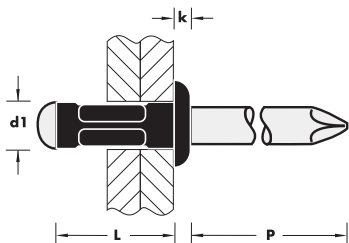

Všechny rozměry v mm.

<b>d1 Ø</b>	Ø $\text{---}$ : 3.1 [3.3 max]
<b>d2 Ø</b>	: 6.0 [+/-0.24]
<b>k</b>	: ≤1.4
<b>P</b>	: ≥27
<b>d3</b>	: ≈1.7
	⊕ : 654 N
	⊖ : 522 N

Všechny rozměry v mm.

<b>d1 Ø</b>	Ø $\text{---}$ : 3.3 [3.5 max]
<b>d2 Ø</b>	: 6.0 [+/-0.24]
<b>k</b>	: ≤1.4 [+/-0.75]
<b>P</b>	: ≥27
<b>d3</b>	: ≈1.78
	⊕ : 980 N
	⊖ : 680 N

	L [+1/-0.2]	Objednáací číslo
1.0- 4.0	6.0	11813006
1.0- 5.5	8.0	11813008
2.5- 7.0	10.0	11813010
4.5- 9.0	12.0	11813012

0.5- 3.0	6.0	11813206
0.5- 5.0	8.0	11813208
2.0- 6.5	9.5	11813209
2.5- 7.0	10.0	11813210
3.5- 8.0	11.1	11813211
4.5- 9.0	12.0	11813212
5.5- 9.5	12.7	11813213
6.5-11.0	14.0	11813214
8.5-13.0	16.0	11813216

Všechny rozměry v mm.

<b>d1 Ø</b>	Ø $\text{---}$ : 4.1 [4.3 max]
<b>d2 Ø</b>	: 8.0 [+/-0.29]
<b>k</b>	: ≤1.7 [+/-0.1]
<b>P</b>	: ≥27
<b>d3</b>	: ≈2.18
	⊕ : 1600 N
	⊖ : 1150 N

Všechny rozměry v mm.

<b>d1 Ø</b>	Ø $\text{---}$ : 4.9 [5.2 max]
<b>d2 Ø</b>	: 9.5-9.8 [+/-0.29]
<b>k</b>	: ≤2.0 [+/-0.1]
<b>P</b>	: ≥27
<b>d3</b>	: ≈2.78
	⊕ : 2350 N
	⊖ : 1500 N

	L [+1/-0.2]	Objednáací číslo
0.5- 2.5	6.0	11814006
0.5- 4.5	8.0	11814008
1.0- 6.0	9.5	11814009
1.5- 6.5	10.0	11814010
3.5- 8.5	12.0	11814012
4.0- 9.5	12.7	11814013
5.5-10.5	14.0	11814014
7.5-12.5	16.0	11814016
8.5-13.5	17.0	11814017
9.5-14.5	18.0	11814018
11.5-16.5	20.0	11814020

0.5- 5.0	10.0	11814810
0.5- 5.5	10.3	11814811
2.0- 7.0	12.0	11814812
4.0- 9.0	14.0	11814814
5.0-10.5	15.1	11814815
6.0-11.0	16.0	11814816
7.0-12.0	17.0	11814817
8.0-13.0	18.0	11814818
10.0-15.0	20.0	11814820
12.0-17.0	22.0	11814822
14.0-19.0	24.0	11814824
14.5-19.5	24.8	11814825
17.0-23.0	27.0	11814827
20.0-25.0	30.0	11814830

ŠIROKOROZSAHOVÉ NÝTY

# Série 1663 + 1441

**HLINÍK**  
AIMg 2,5

**NEREZ**

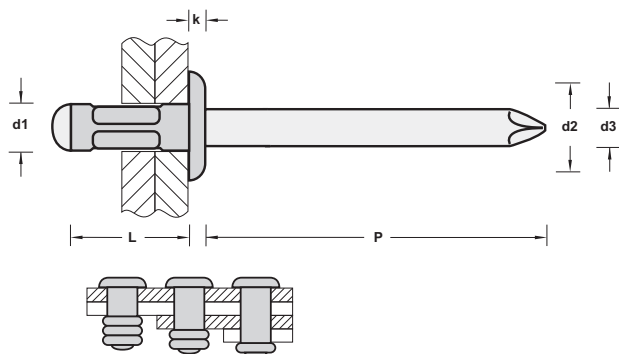

řada 1441 [1.4016]

řada 1663 - d1 - 3, 3,2, 4 mm - mat. [1.4301]

řada 1663 - d1 - 4,8 mm - mat. [1.4567]

Všechny rozměry v mm.

<b>d1 Ø</b>	Ø  : 3.1 - 3.3
<b>d2 Ø</b>	: 6.7
<b>k</b>	: ≤1.3
<b>P</b>	: ≥27
<b>d3</b>	: ≈1.7
	: 900 N
	: 700 N

Všechny rozměry v mm.

<b>d1 Ø</b>	Ø  : 3.3 - 3.4
<b>d2 Ø</b>	: 6.0 - 6.7
<b>k</b>	: ≤1.4
<b>P</b>	: ≥27
<b>d3</b>	: ≈1.78
	: 980 N
	: 680 N

	L	Objednáací číslo
0.8- 4.3	9.1	16635307

	L	Objednáací číslo
0.8- 4.8	7.9	16630410
0.5- 5.0	8.0	14413208
2.0- 6.5	9.5	14413209
3.5- 8.0	11.1	14413211
1.2- 6.3	12.0	16630412
4.0- 7.9	11.2	16630414
5.5- 9.5	16.0	16630416

Všechny rozměry v mm.

<b>d1 Ø</b>	Ø  : 4.1 - 4.2
<b>d2 Ø</b>	: 8.0 - 8.2
<b>k</b>	: ≤1.7
<b>P</b>	: ≥27
<b>d3</b>	: ≈2.1
	: 1600 N
	: 1000 N

Všechny rozměry v mm.

<b>d1 Ø</b>	Ø  : 4.9 - 5.1
<b>d2 Ø</b>	: 9.5 - 10.1
<b>k</b>	: ≤2.0
<b>P</b>	: ≥27
<b>d3</b>	: ≈2.78
	: 2350 N
	: 1300 N

	L	Objednáací číslo
0.5- 3.2	9.3	16630508
0.8- 4.7	10.7	16630510
1.2- 6.3	9.5	16630512
1.0- 6.0	9.5	14414009
4.0- 9.6	12.7	16630516
4.0- 9.5	12.7	14414012
6.4-12.7	16.7	16630521
8.3-13.5	16.9	14414016

	L	Objednáací číslo
1.6- 6.3	10.3	16630613
0.5- 5.5	10.3	14414810
4.8-11.1	15.1	16630619
5.0-10.5	15.1	14414815
6.4-12.7	16.7	16630621
7.0-12.0	16.9	14414816
12.7-19.8	24.5	16630631
14.5-19.5	24.9	14414824

# Série 1002

**HLINÍK**  
AIMg 2,5

**OCEĽ**  
POZINKOVÁNO

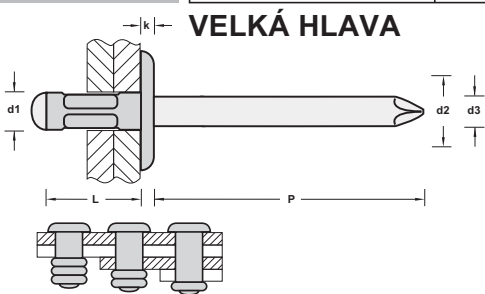

Všechny rozměry v mm.

<b>d1 Ø</b>	Ø  : 4.1 [4.3 max]
<b>d2 Ø</b>	: 12.0 [+/-0.5]
<b>k</b>	: ≤2.5
<b>P</b>	: ≥27
<b>d3</b>	: ≈2.18
	: 1600 N
	: 1150 N

Všechny rozměry v mm.

<b>d1 Ø</b>	Ø  : 4.9 [5.2 max]
<b>d2 Ø</b>	: 14.0 [+/-0.24]
<b>k</b>	: ≤2.5
<b>P</b>	: ≥27
<b>d3</b>	: 2.78
	: 2350 N
	: 1500 N

Všechny rozměry v mm.

<b>d1 Ø</b>	Ø  : 3.3 [3.5 max]
<b>d2 Ø</b>	: 9.5 [+/-0.5]
<b>k</b>	: ≤2.0
<b>P</b>	: ≥27
<b>d3</b>	: 1.78
	: 980 N
	: 680 N

	L	Objednáací číslo
0.5- 5.0	8.0	10023208
2.0- 6.0	9.5	10023209
2.5- 7.0	10.0	10023210
3.5- 8.0	11.1	10023211
4.5- 9.0	12.0	10023212
6.5-11.0	14.0	10023214
8.5-13.0	16.0	10023216

	L	Objednáací číslo
0.5- 4.5	8.0	10024008
1.5- 6.5	10.0	10024010
2.5- 7.5	11.1	10024011
3.5- 8.5	12.0	10024012
4.0- 9.5	12.7	10024013
5.5-10.5	14.0	10024014
7.5-12.5	16.0	10024016
8.5-13.5	17.0	10024017
9.5-14.5	18.0	10024018
11.5-16.5	20.0	10024020

	L	Objednáací číslo
0.5- 5.0	10.0	10024810
2.0- 7.0	12.0	10024812
4.0- 9.0	14.0	10024814
6.0-11.0	16.0	10024816
8.0-13.0	18.0	10024818
10.0-15.0	20.0	10024820

ŠIROKOROZSAHOVÉ NÍTY

## Série 1641 + 1003



### VELKÁ HLAVA

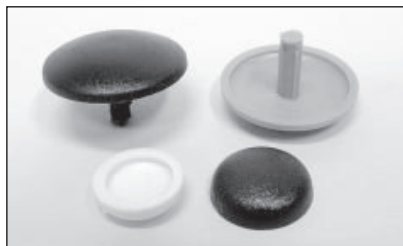
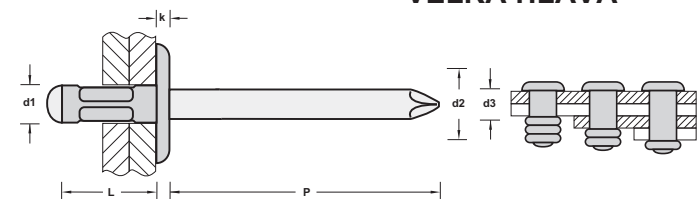

Plastové krytky na zvl. poptávku.

Všechny rozměry v mm.

d1 Ø	Ø  : 4.9 - 5.0
d2 Ø	: 15.6- 16.0 [+/-0.5]
k	: 2.2-2.5
P	: ≥27
d3	: ≈2.7- 2.8
	: 2100 N
	: 1300 N

**4.8**

+0.05  
-0.15

	L [+1/-0.2]	Objednací číslo
0.5- 5.0	10.0	10034810
1.6- 6.3	10.3	16410613
2.0- 7.0	12.0	10034812
4.0- 9.0	14.0	10034814
6.0-11.0	16.0	10034816
3.2- 9.3	17.0	16410617
4.8-11.1	18.7	16410619
8.0-13.0	18.0	10034818
6.4-12.7	20.2	16410621
10.0-15.0	20.0	10034820
12.0-17.0	22.0	10034822
14.0-19.0	24.0	10034824
12.7-19.8	24.8	16410631
16.0-22.0	27.0	10034827

## Série 1643



### VELKÁ HLAVA A2 [1.4541]

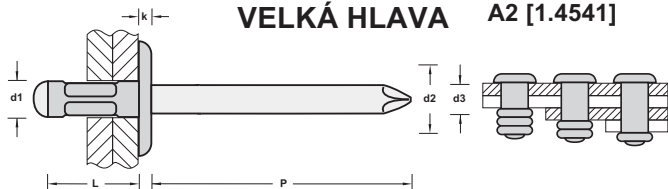

Všechny rozměry v mm.

d1 Ø	Ø  : 4.9 - 5.0
d2 Ø	: 15.6
k	: 1.8
P	: ≥30
d3	: ≈2.8
	: 2335 N
	: 1310-1535 N (dle délky nýtu)

**4.8**

+0.05  
-0.15

	L [+1/-0.2]	Objednací číslo
1.6- 6.4	10.3	16430613
6.4-12.7	16.9	0621
12.7-19.8	24.8	0631

## Série 1604 + 1004



### ZAPUŠTĚNÁ HLAVA

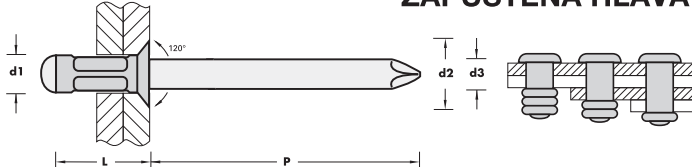

Všechny rozměry v mm.

d1 Ø	Ø  : 4.1-4.2 [4.3 max]
d2 Ø	: 6.3-8.0 [+/-0.24]
P	: ≥27
d3	: ≈2.1
	: 1330 N
	: 1150 N

**4.0**

+0.05  
-0.15

	L [+1/-0.2]	Objednací číslo
1.5- 4.5	8.0	10044008
1.5- 6.5	10.0	10044010
2.8- 7.9	11.2	16040514
2.5- 7.5	11.3	10044011
3.5- 8.5	12.0	10044012
5.5-10.5	14.0	10044014
3.6- 8.8	15.1	16040515

Všechny rozměry v mm.

d1 Ø	Ø  : 4.9 - 5.0
d2 Ø	: 9.0 - 9.5
P	: ≥27
d3	: ≈2.8
	: 2355 N
	: 1310 N

**4.8**

+0.05  
-0.15

	L	Objednací číslo
1.5- 5.0	10.0	10044810
2.0- 7.0	12.0	10044812
3.2- 7.9	12.0	16040615
4.0- 9.0	14.0	10044814
6.0-11.0	16.0	10044816
6.3-12.7	16.8	16040621
7.0-12.0	16.9	10044817

Všechny rozměry v mm.

d1 Ø	Ø  : 3.3-3.4 [3.5 max]
d2 Ø	: 5.3-6.0 [+/-0.24]
P	: ≥27
d3	: ≈1.8
	: 980 N
	: 680 N

**3.2**

+0.05  
-0.15

	L [+1/-0.2]	Objednací číslo
1.5- 5.0	8.0	10043208
2.4- 6.3	12.2	16040412
2.5- 6.5	9.7	10043209
2.5- 7.0	10.0	10043210
4.5- 9.0	12.0	10043212
4.0- 7.9	13.4	16040414
5.5- 9.5	14.8	16040416

# Série 1451



A2 [1.4301]

A2 [1.4301]

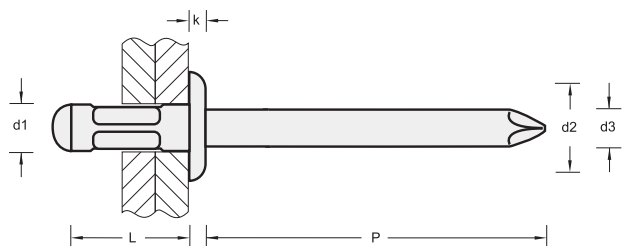

Všechny rozměry v mm.

d1 Ø	Ø  : 3.3	L		Objednáací číslo
		1.5- 4.0	8.0	
<b>3.2</b>	d2 Ø : 7.2 [+/-0.25]			14513208
	k : 1.0 [+/-0.15]			
	P : ≥27			
+0.08	d3 : ~2.1			
-0.10	: 1780 N			
	: 1570 N			

Všechny rozměry v mm.

d1 Ø	Ø  : 4.1	L		Objednáací číslo
		1.5- 5.0	10.0	
<b>4.0</b>	d2 Ø : 8.1 [+/-0.25]	3.5- 7.0	12.0	14514010
	k : 1.2 [+/-0.15]	6.0- 9.5	15.0	4012
	P : ≥27			4015
+0.05	d3 : ~2.6			
-0.15	: 3350 N			
	: 4200 N			

Všechny rozměry v mm.

d1 Ø	Ø  : 4.9	L		Objednáací číslo
		1.5- 5.0	10.0	
<b>4.8</b>	d2 Ø : 9.8 [+/-0.25]	3.0- 7.0	12.0	14514810
	k : 1.75 [+/-0.15]	6.5-10.0	15.0	4812
	P : ≥27	9.0-12.5	17.5	4815
+0.05	d3 : ~3.2			4817
-0.15	: 4300 N			
	: 5000 N			

ŠIROKOROZSAHOVÉ NÝTY